

MÖGLICHKEITEN Hölzer Tischplatten



46 Leem



47 Sand



50 Naturel



56 Smoke



54 Eiche geölt



54 Nussbaum geölt



58 White wash



62 Eiche Vintage
nicht mit Epoxi möglich



63 Black oak
nicht mit Epoxi möglich



65 White grey geölt
nicht mit Epoxi möglich

Extra info's zu den Tischplatten!

Platte 6.) Air Platte:

100 cm breite Platten verjüngen auf 90 cm

90 cm breite Platten verjüngen auf 80 cm

Alteiche Platten sind nicht möglich mit Epoxidharz

Sondermassen sind nicht möglich

Achtung, Einzelne Platten oder Füße nur mit 25% Aufpreis!

MÖGLICHKEITEN *Tischplatten*

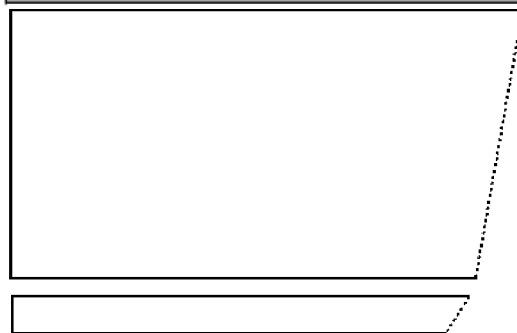

1.) gerade Kante

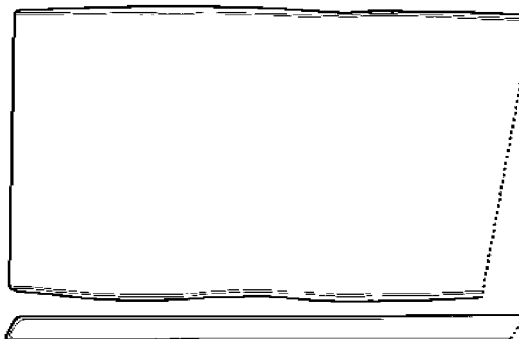

2.) organische Kante

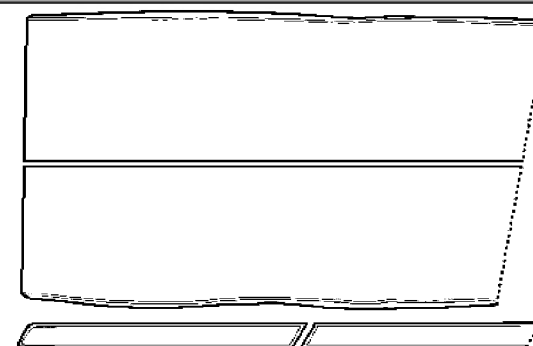

3.) organisch geteilte Platte
Ansteckplatte nicht möglich

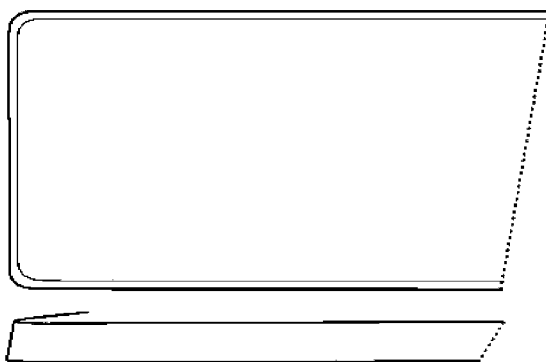

5.) gerade Kante gerundet
Ansteckplatte nicht möglich

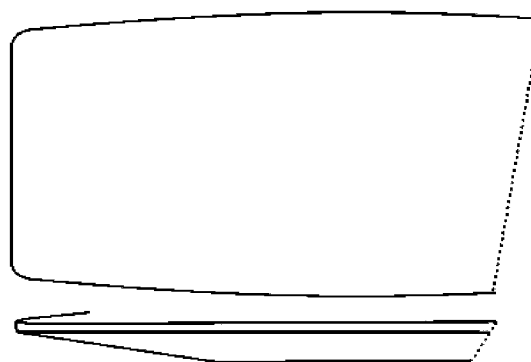

6.) Air Platte
Ansteckplatte nicht möglich

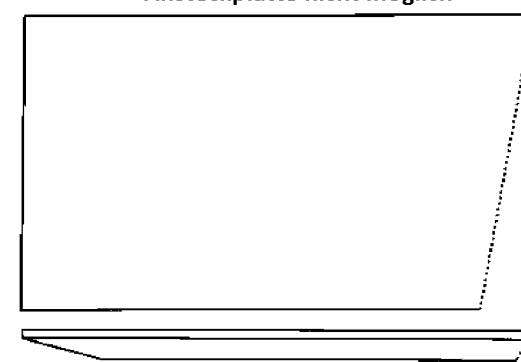

4.) Schweizer Kante

Plattengrößen in cm	Eiche	Alt Eiche	Nussb.
160 x 90 / 100			
180 x 90 / 100			
200 x 90 / 100			
225 x 90 / 100			
250 x 90 / 100			

MÖGLICHKEITEN Stahlwangen

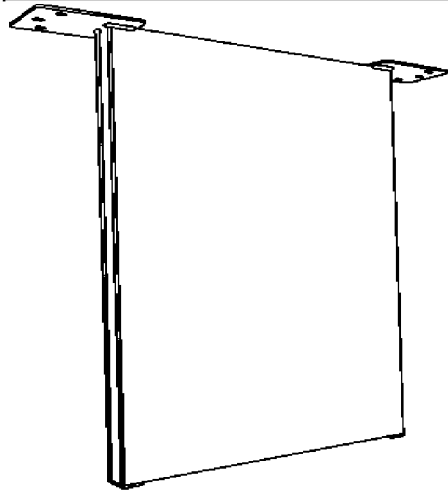

A.) Stahlwange
Schweissnaht 40 mm dick

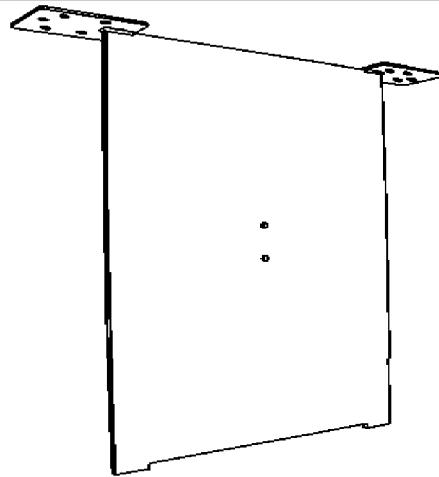

B.) Stahlwange
fein 10 mm dick + Quertraverse
silber, weiss oder schwarz

Stahlwange	€
A	
B	

MÖGLICHKEITEN U-Profile Edelstahl

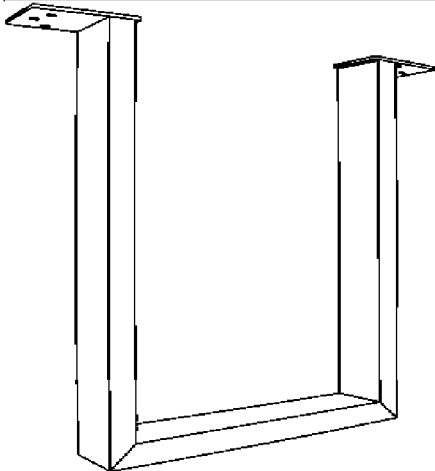

D.) U-Profil dick 100*40
auch möglich in schwarz

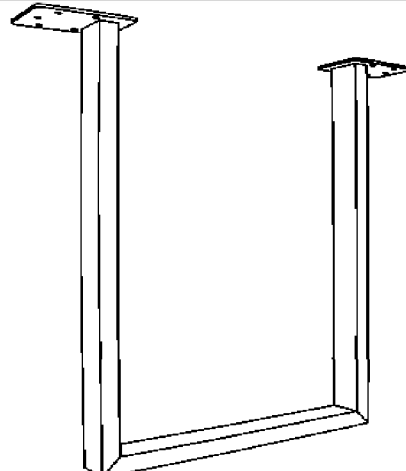

E.) U-Profil fein 60*30
auch möglich in schwarz

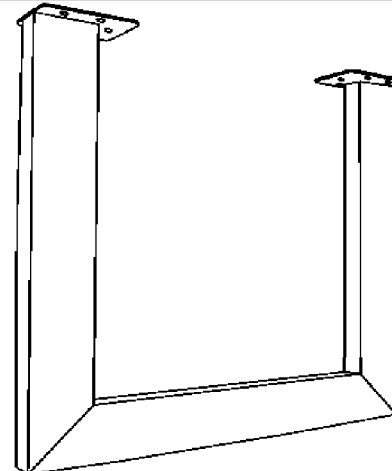

L.) Hochkant Profil 40*100
auch möglich in schwarz

Stahlwange	€
D	
E	
L	

MÖGLICHKEITEN Holzbeine

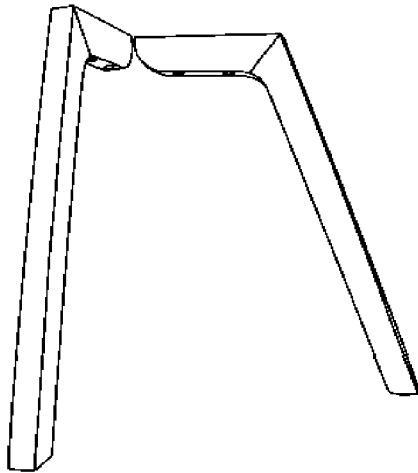

F.) eckig

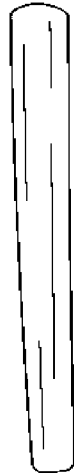

G.) rund

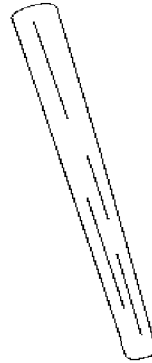

N.) abgerundet

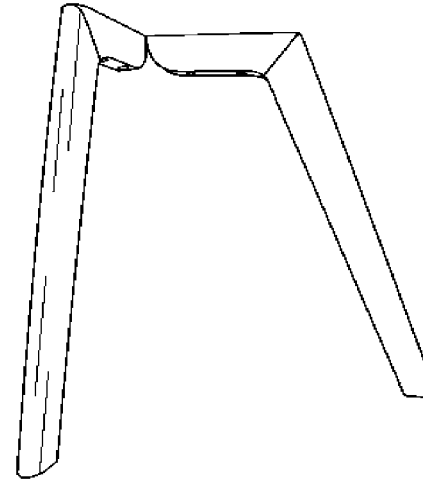

Holzbeine	Eiche	Nussb.
F		
G		
N		

MÖGLICHKEITEN Holzwanen

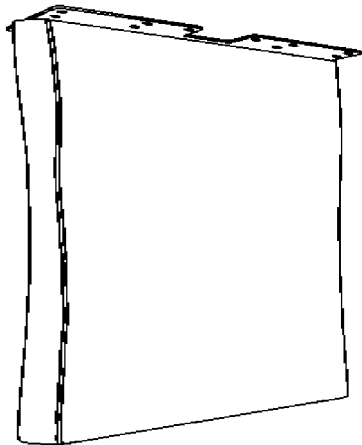

H.) organische Wange 40 mm dick
mit Quertraverse

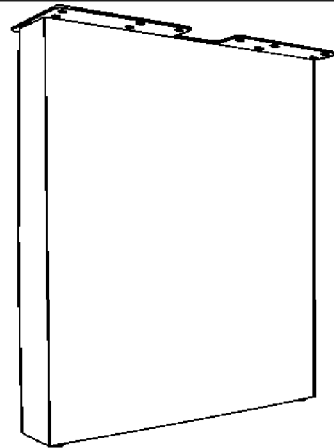

I.) gerade Wange 80 mm dick

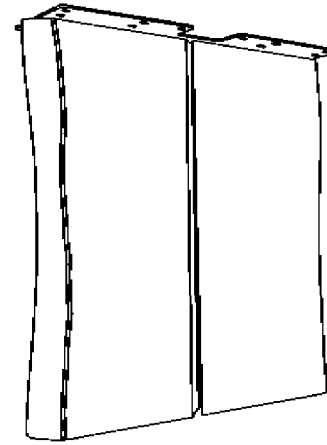

J.) organisch geteilt 40 mm dick
mit Quertraverse

Holzbeine	Eiche	Nussb.
H		
I		
J		

MÖGLICHKEITEN Sonstige

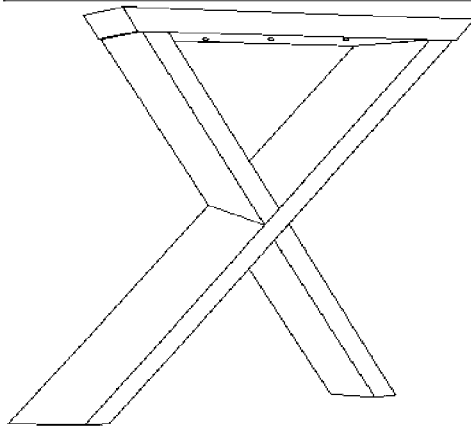

M.) X Fuss
Füßbreite 18 cm

Holzbeine	Eiche	Nussb.
M		

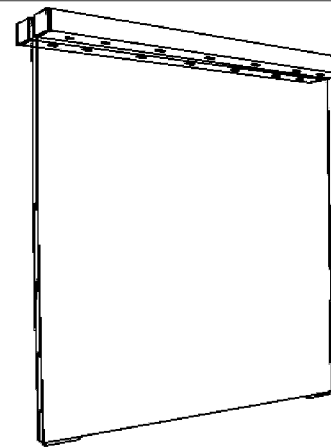

K.) Glaswange 15 mm dick
Ansteckplatten nicht möglich

Glaswange	€
K	

SONSTIGES



Epoxidharz dunkel



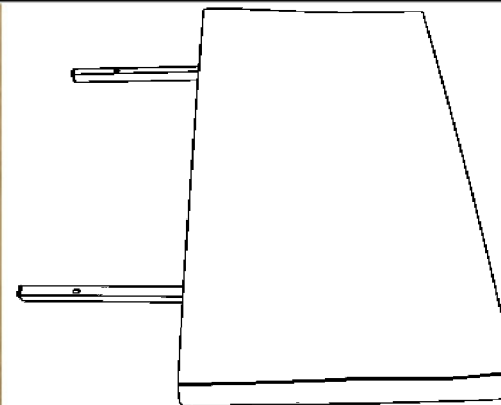

Epoxidharz farblos



Ansteckplatte á 50cm

Epoxidharz	Tischplatte	Ansteckpl.stk
EK		
Ansteckplatten	Eiche	Nussbaum
EK pro Stück		

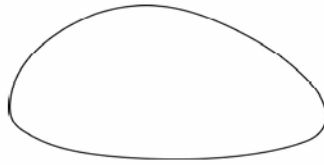
<u>Abbildung</u>	<u>Art. Nr.</u>	<u>Modellname</u>	<u>Maße</u>	<u>Preis</u>	<u>Preis</u>
		Aktions Tisch		Eiche	Mit Epoxid
		LN 1065	160 x 100		
		Schweizer Kante	180 x 100		
		RVS U Profil fein	200 x 100		
			225 x 100		
			250 x 100		
Ansteckplatten EK pro Stuck			1 x 50		
Nur lieferbar in Eiche. - Möglich mit Epoxidharz farblos oder Schwarz					
				Geölt	Vintage
		Aktions Tisch			
		ADAM	160 x 90		
		Platte 22 mm	180 x 90		
			200 x 90		
Nur Lieferbar in Eiche. - Epoxidharz nicht möglich					
	H-T-B			Geölt	Elfenbein
	86x68x51	Aktions Stuhl			
	7236	EVA	Royal		
			Pampa		
Möglich in P32 Eiche geölt, P65 White grey geölt und P23 Elfenbein					
Möglichkeiten in Stoff Royal:		Anthrazit, Navy und Petrol - Nahte immer Orange			
Möglichkeiten in Stoff Pampa:		Dessert, Beige und Anthrazit - Nahte immer Beige			
	3298	PARIS Platte		Eiche	Nussbaum
			200 x 105		
Möglich in Eiche u. Amerikan. Nussb. Geölt, Eliptische Platte					
Lieferbar mit Füß A - D - E - I - K - L von unseres Tischsystem					